

Resonanzboden Unteransicht

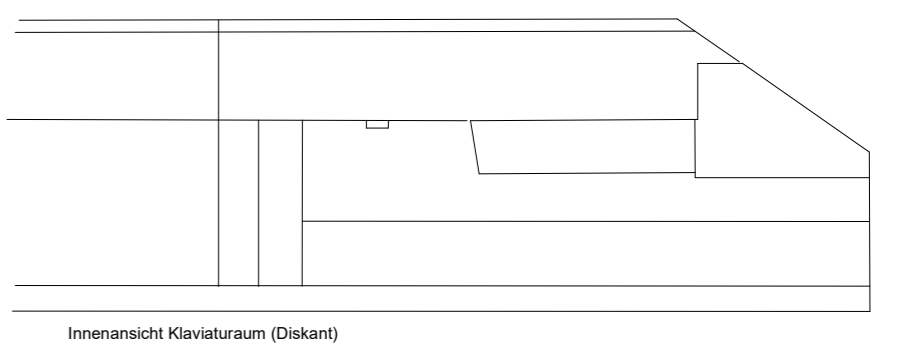
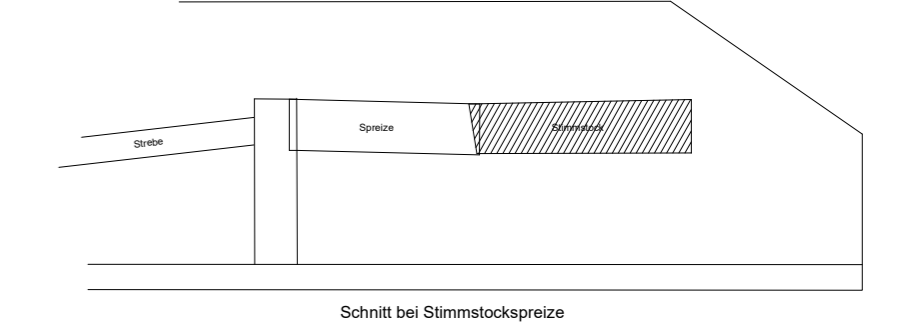
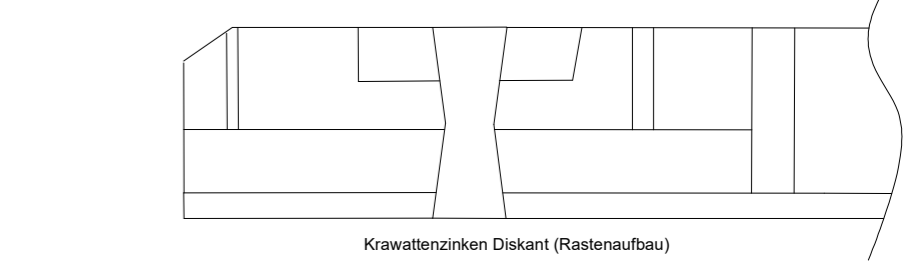
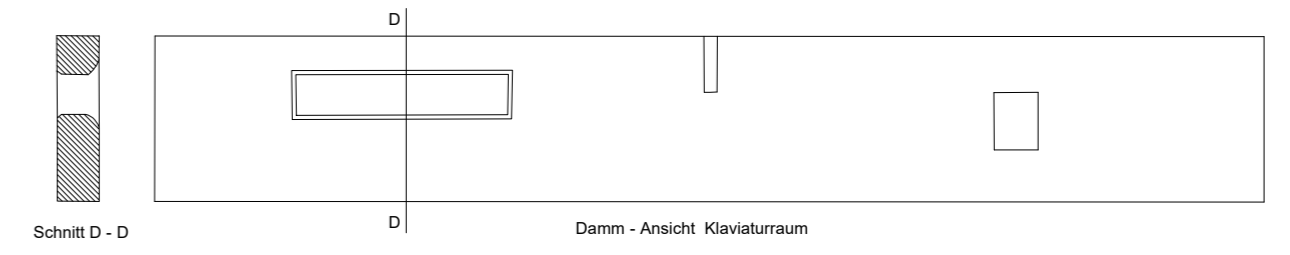
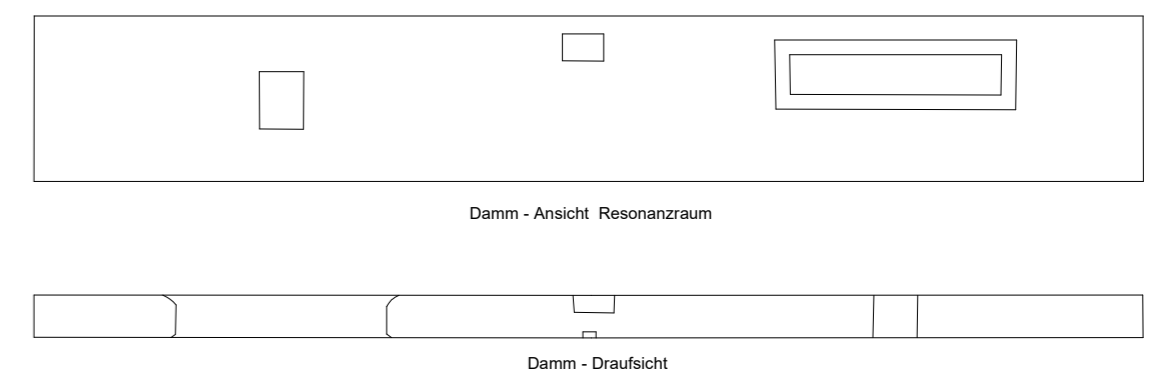
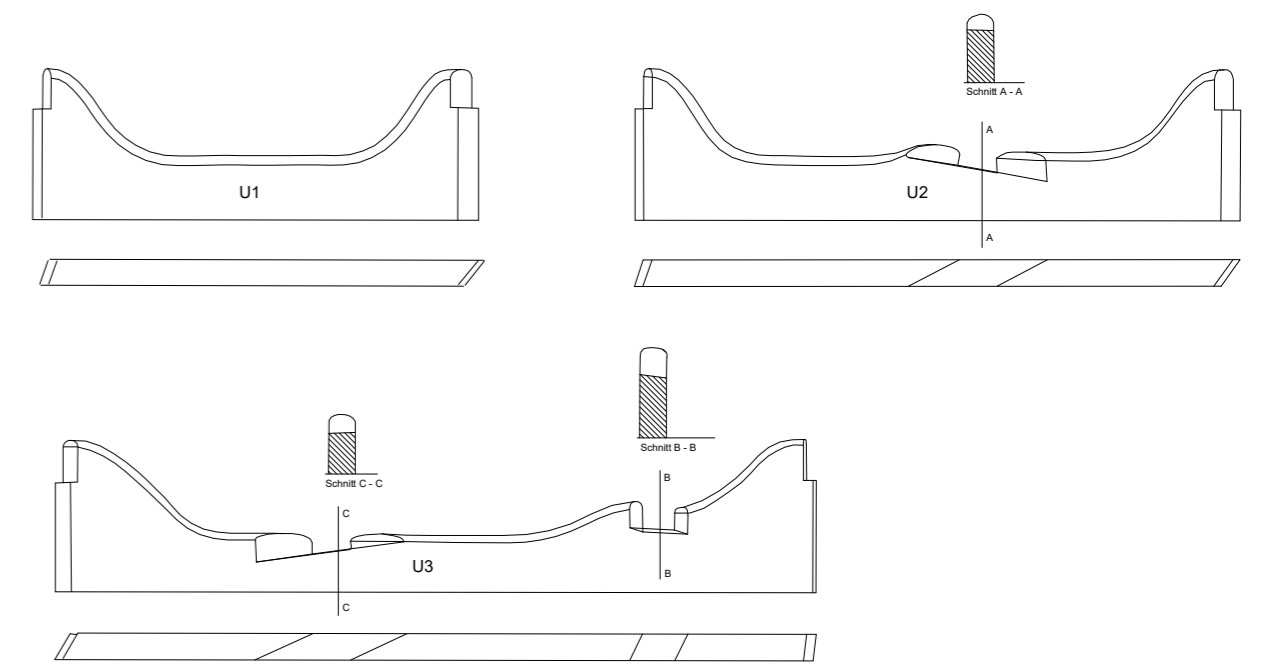
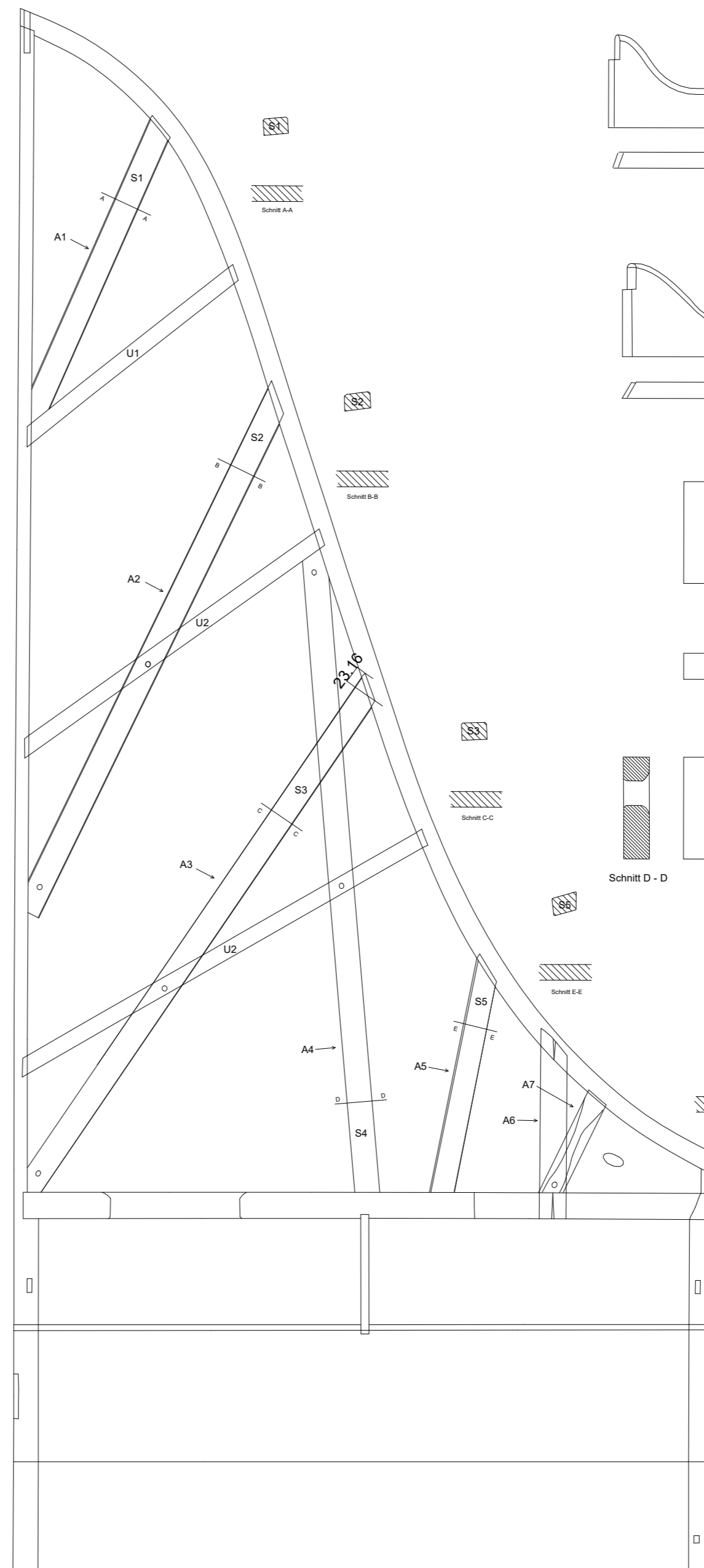
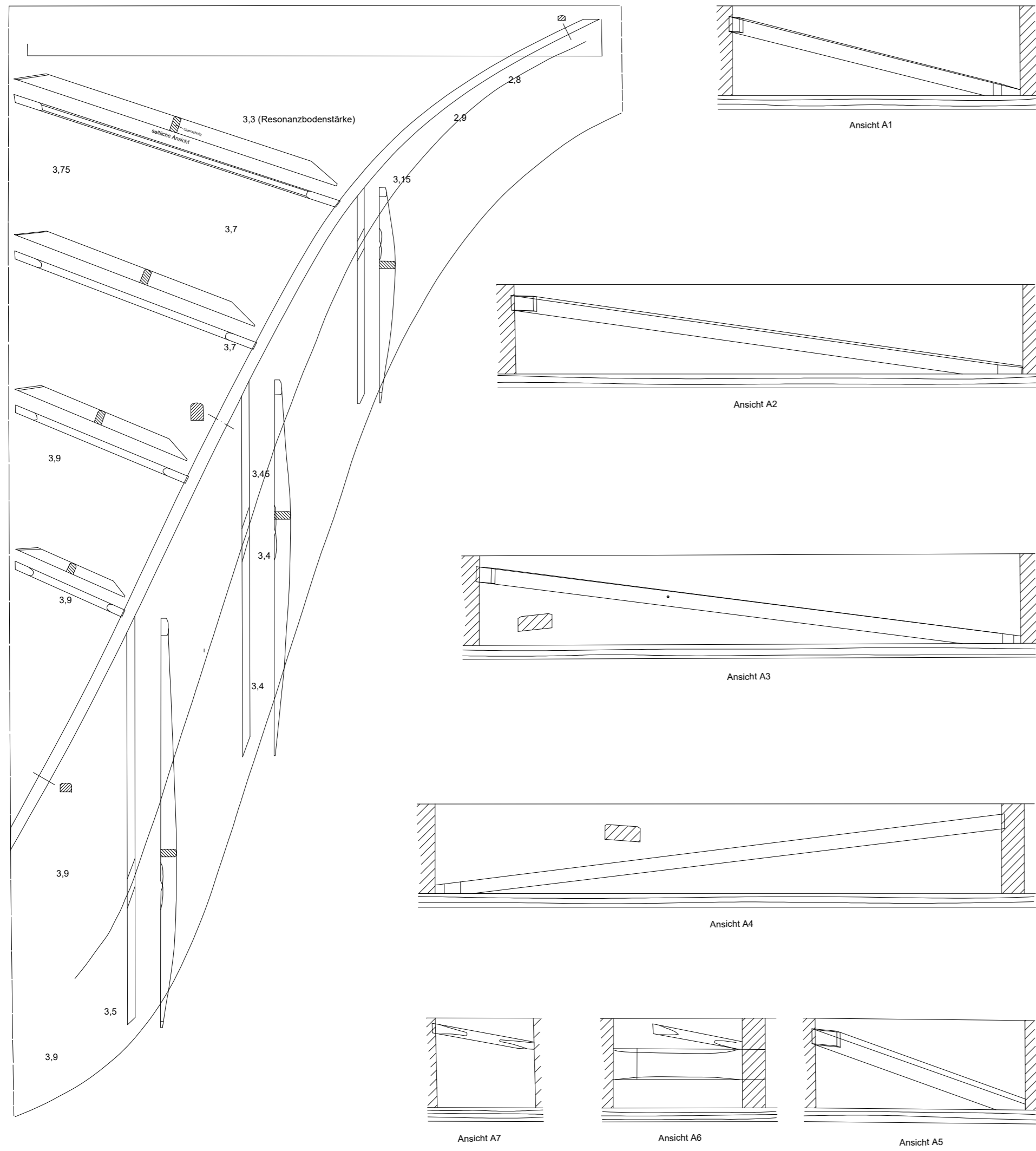

| | | | |
|--|----------------------|---|----------------------|
| Greifenberger Institut | | | |
| Instrument: Schule J.A. Stein ca.1780 | | Bauteil: Reverse Engineering Rekonstruktion von Rastenaufbau + Resonanzboden | |
| Datum: 01.04.2022 | Bearbeitung: A.L. | Zeichnungsnr.: 06/22 | Maßstab: skaliert |